



INSTALLATION INSTRUCTIONS

NATURAL ROLLER SHADES

Thank you for purchasing Natural Roller Shades from the Inspired Shades Collection.

With proper installation, your shades should look beautiful and provide years of service. Please check all parts and review this manual before starting installation.

NOTE: If installing motorized shades, the motorization manual is provided separately. Please refer to that manual for instructions on programming and operating motorized shades.

CONTENTS:

Page 1: Shade Care and Cleaning	Pages 6 - 7: Cassette
Page 2: Standard Open Roll (single shades)	Page 8: Traditional Valance
Page 3: Dual Bracket (double shades)	Page 9: Box Valance
Pages 4 - 5: Decorative Metal Bracket	Page 12: Shade Warranties

TOOLS THAT MAY BE REQUIRED:

Pencil, Tape Measure, Drill, Screw Driver, Level and Step Stool

NOTE: For drywall (wallboard) or plaster, use anchors designed for hollow walls (not included). For concrete, stone, and brick, use a masonry drill bit and masonry anchors (not included).

SHADE CARE AND CLEANING:

Because of the material content for these fabrics, steaming and spot cleaning is not recommended.

When dusting is required, be sure to use something gentle. We recommend using a vacuum brush or a duster.

Following these tips will help to extend the life of your shades and ensure that they stay beautiful for years to come.

WARNING

STRANGULATION HAZARD — Young children can be strangled by cords. Immediately remove this product if a cord longer than 22 cm or a loop exceeding 44 cm around becomes accessible.

MISE EN GARDE

RISQUE D'ÉTRANGLEMENT — Les enfants en bas âge peuvent s'étrangler avec des cordes. Enlevez immédiatement ce produit si une corde mesurant plus de 22 cm devient accessible ou si le contour d'une boucle de plus de 44 cm devient accessible.

STANDARD OPEN ROLL (SINGLE SHADES)

If open roll shade was ordered with a Box Valance, see page 9 before starting installation.

STEP 1: INSTALL BRACKETS

Roller shade brackets can be installed to the wall (face mount) or to the ceiling or underside of the window recess (top mount).

Determine the desired location for the brackets. Mark the position of the brackets and ensure they are the correct distance apart and that they are level and in line with each other.

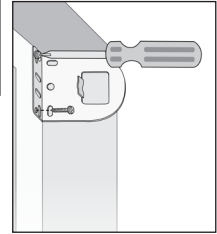
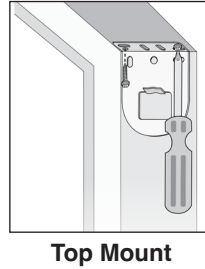
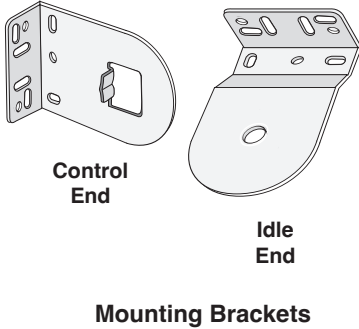

Face Mount

STEP 2: INSTALL SHADE

Insert the control side of the shade into the control end bracket, ensuring the lug on the bracket fits into the slot. Then, push in the pin on the idle end of the shade and move the shade up so that the pin engages with the hole in the idle end bracket. When the pin snaps into the bracket, the shade is securely installed.

NOTE: Cordless open roll shades must be fully rolled on the tube before installation. If not fully rolled on the tube, the shade will not raise completely in operation. Cordless open roll brackets must also be installed at exactly the ordered width for the shade to operate properly.

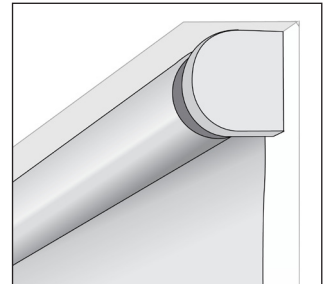

Shade Installed

DUAL BRACKET (DOUBLE SHADES)

If dual shade was ordered with a Box Valance, see page 9 before starting installation.

STEP 1: INSTALL BRACKETS

Dual roller shade brackets can be installed to the wall (face mount) or to the ceiling or underside of the window recess (top mount).

Determine the desired location for the brackets. Mark the position of the brackets and make sure they are the correct distance apart and that they are level and in line with each other.

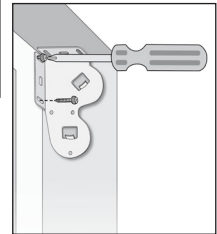
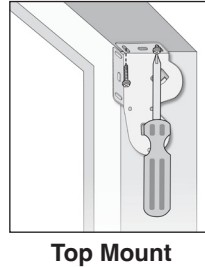
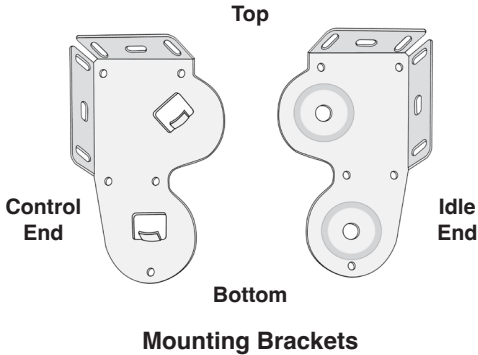

STEP 2: INSTALL SHADE

Install the bottom shade followed by the top shade. The shade installed on the bottom of the bracket will always be standard roll. The shade installed on the top of the bracket will always be reverse roll.

Insert the control side of the shade into the control end bracket, ensuring the lug on the bracket fits into the slot. Then, push in the pin on the idle end of the shade and move the shade up so that the pin engages with the hole in the idle end bracket. When the pin snaps into the bracket, the shade is securely installed.

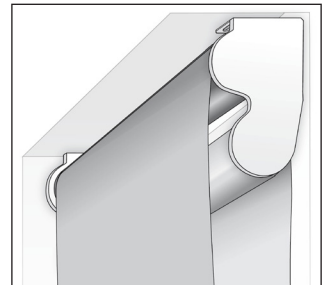

NOTE: Cordless open roll shades must be fully rolled on the tube before installation. If not fully rolled on the tube, the shade will not raise completely in operation. Cordless open roll brackets must also be installed at exactly the ordered width for the shade to operate properly.

Dual Bracket Installed

OPEN ROLL - DECORATIVE METAL BRACKETS

Note (Wand Motor Installations): If installing brackets with wand motors, brackets must be installed top mount. Wand controls must be installed to the motor head prior to installing the wand motor control side to the bracket.

Note (Cordless Installations): Cordless open roll shades must be fully rolled on the tube before installation. If not fully rolled on the tube, the shade will not raise completely in operation. Cordless open roll brackets must also be installed at exactly the ordered width for the shade to operate properly.

STEP 1: INSTALL BRACKETS

1. Installation brackets are equipped to fit either the idle end or control end of your shade.

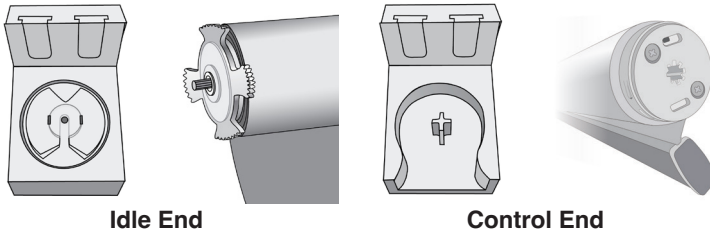

2. The brackets can be installed to the wall (face mount) or to the ceiling or underside of the window recess (top mount).

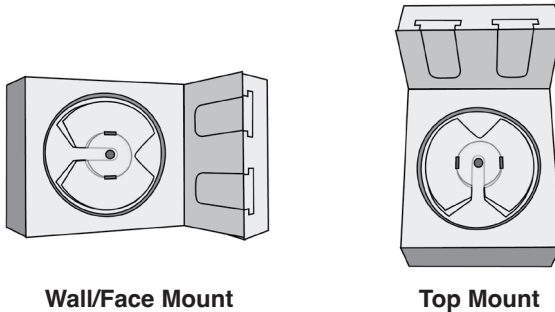

3. Determine the location for the brackets and the mounting style. Mark the position of the brackets and confirm they are the correct distance apart. Confirm brackets are level and in line.

4. Once the brackets are installed, cover the installation screws on the foot of the bracket with screw covers.

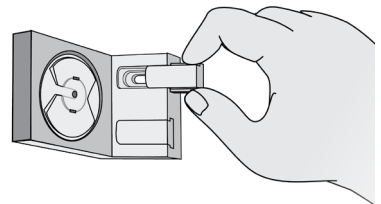

Screw Cover

OPEN ROLL - DECORATIVE METAL BRACKETS

STEP 2: INSTALL SHADE

1. Insert the motor head into the control end bracket.

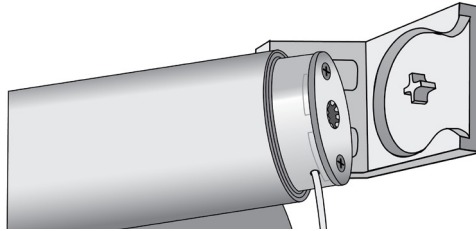

Face Plate and Motor Head Alignment

2. The idle end of the shade has a dial which can be turned to retract the idle end pin. Once the pin is retracted, the idle end can be aligned with the opening of the idle end bracket. Once in place, turn the dial to release the idle end pin to hold the shade in place.

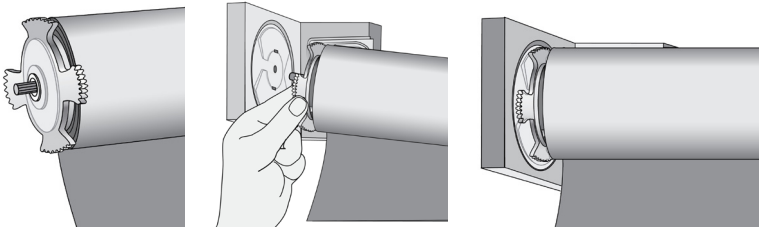

Idle Side Installation

3. If your shade requires removal after installation, turn the dial on the idle end to retract the idle end pin and remove the shade from the brackets.

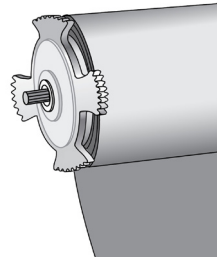

Shade Removal

CASSETTE INSTALLATION

STEP 1: INSTALL BRACKETS

Brackets for roller shades with cassettes can be installed to the wall (face mount) or to the ceiling or underside of the window recess (top mount).

Note: Brackets must be installed level in order for the cassette to install properly. Use the provided bracket shims if installing to uneven surfaces.

For wall/face mount, move on to INSTALL CASSETTE GRIPS.

For ceiling/top mount shades, move on to INSTALL SHADE.

Ordered Width (Inches)	Brackets Supplied
Up to 40"	2 Brackets
Between 40" and 63"	3 Brackets
Between 63" and 90"	4 Brackets
Between 90" and 114"	5 Brackets

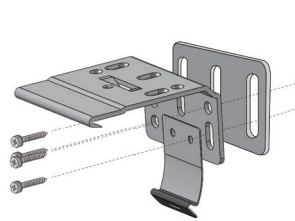

Wall/Face Mount
(with shims)

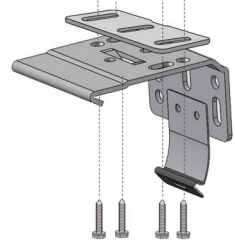

Ceiling/Top Mount
(with shims)

WALL/FACE MOUNT ONLY: INSTALL CASSETTE GRIPS

Wall/Face mount cassettes should be installed with the provided cassette grip. Cassette grips attach to the back of the cassette and keep the cassette from tilting forward in face mount installations.

If installing wall/face mount with spacer blocks, an L-shaped spacer block is provided. Please ensure the cassette grip is positioned on top of the spacer block.

Note: Cassette grips will have a thin side and a thick side. The thin side should face the wall if the cassette brackets are installed without shims. The thick side should face the wall if the cassette brackets are installed with shims.

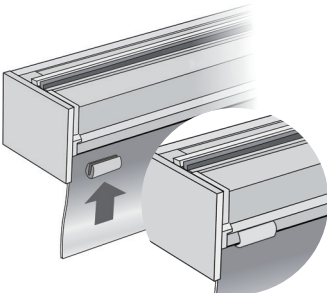

Cassette Grip Installation

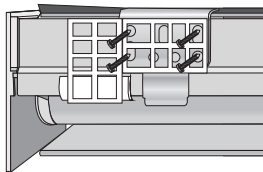

Spacer Block with Cassette Grip

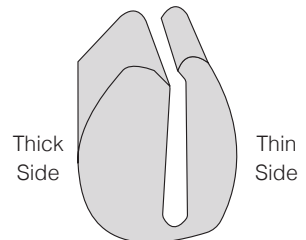

Cassette Grip

CASSETTE INSTALLATION

STEP 2: INSTALL SHADE

Position the lip of the bracket under the front rib on the top of the cassette.

Once in position, push the back of the shade up into the tab of the installation bracket. You will hear a click once the back of the cassette and tab of the bracket are engaged.

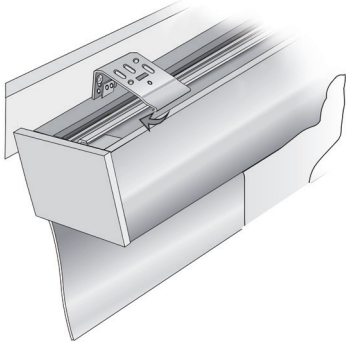

Position Lip of Bracket under Front Rib of Cassette

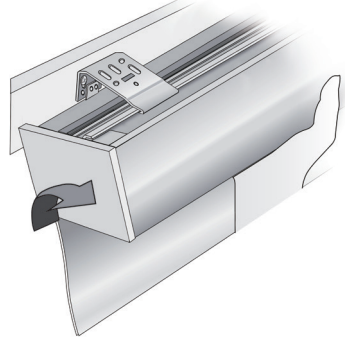

Click Bottom of Cassette into Bracket Tab

If your shade requires removal after installation, use a flat head screw driver to unhook the tab on the cassette installation bracket from the bottom of the cassette.

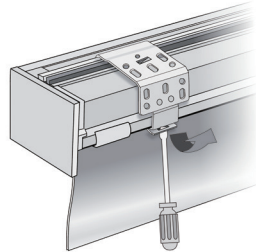

Cassette Removal

TRADITIONAL VALANCE

OPTION A: FACE MOUNT

STEP 1: INSTALL BRACKETS

Center your shade on its corresponding window and mark in pencil where the slots in the head rail fall. Ensure the shade is level while marking. Position the brackets within the marked slot locations, and screw into place.

STEP 2: INSTALL SHADE

Remove the wing nuts from the threaded posts and install the shade by sliding the bracket's threaded posts through the slots in the head rail. Re-attach the wing nuts, screwing them on tightly to hold the head rail firmly in place.

OPTION B: TOP MOUNT

Shades that are top mounted can be installed using the mounting bracket as outlined in Option A, or can be installed directly through the head rail by following the steps below.

STEP 1: PRE-DRILL HEAD RAIL

Pre-drill holes in the shade head rail that align with the slots of the head rail.

STEP 2: INSTALL SHADE

Holding the shade in place in its installation position, use the installation screws provided to screw directly through the shade head rail into the pre-drilled holes to install the shade.

Ordered Width (Inches)	Brackets Supplied
Up to 42"	2 Brackets
Between 42" and 60"	3 Brackets
Between 60" and 70"	4 Brackets
Between 70" and 85"	5 Brackets
Above 85"	6 Brackets

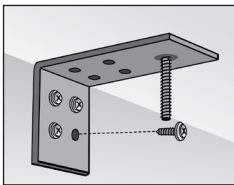

Face Mount

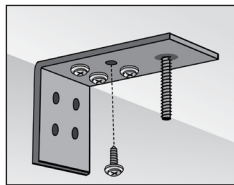

Top Mount

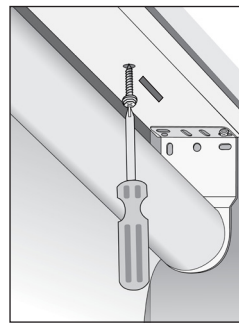

Through Head Rail

BOX VALANCE

STEP 1: INSTALL SHADE BRACKETS

See Step 1 on page 2 for Single Shade Bracket Installation or Step 1 on page 3 for Double Shade Bracket Installation.

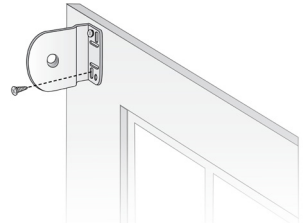

Bracket Install

STEP 2: INSTALL VALANCE BRACKETS (FACE MOUNT)

For Top Mount, move on to Step 3.

For Face Mount, you will have received L-brackets in pairs. These will be stacked in your installation to allow the Box Valance to be installed face mount. Install the wall side L-bracket above where your shade will mount.

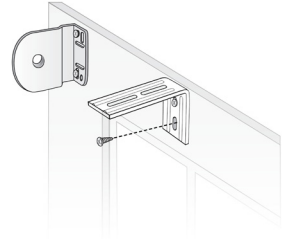

Face Mount Bracket

STEP 3: INSTALL VALANCE

For Top Mount, attach the L-brackets so they are aligned with the top of the inside of the valance. Install directly to the mounting surface.

For Face Mount, attach the valance side brackets so they are aligned with the top of the inside of the valance, making sure they match the placement of the wall side L-brackets. Then, install the valance by placing the valance side L-bracket on top of the wall side L-bracket and use the nut and bolt provided to hold in place.

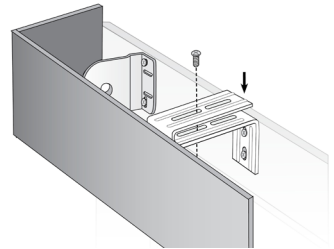

Valance Install

STEP 4: INSTALL SHADE

See Step 2 on page 2 for Single Shade Installation or Step 2 on page 3 for Double Shade Installation.

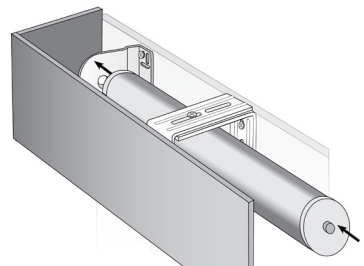

Shade Install

NOTE: WIDE BOX VALANCES

Wide Box Valances will be split. Use the provided flat support to connect the box valances. The provided Keystone can be used to cover the split.

Wide Box Valances will be supplied with extra L-brackets. Space all brackets evenly to provide additional support.

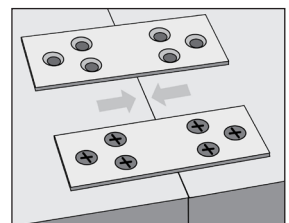

Flat Support

NOTES

NOTES

INSPIRED SHADES COLLECTION WARRANTIES

Limited No Questions Asked Warranty

The Pro Design LLC Limited "No Questions Asked" Warranty is offered exclusively to Budget Blinds' customers purchasing products from the Inspired Shades Collections only. This warranty allows a one-time complimentary replacement or repair should a shade become damaged or inoperable after the initial installation.

This warranty is valid for five years from the original date of purchase. Replacement or repair will be at Pro Design LLC's discretion.

The replacement shade will be made to the same size and specifications as the original shade. The replacement shade must be ordered in the same pattern and color. If the original pattern or color is not available, the shade will be replaced with the closest available option. If a shade is replaced, there may be variations in the color or texture of the original and replaced shades.

This warranty does not cover motors or batteries for motorized shades. This warranty does not cover trip charges or labor charges for removal or installation.

This warranty is provided to the original purchaser only with proof of purchase and does not cover damage caused by removal, storage or reinstallation of the shades. This warranty is only available through Budget Blinds franchisees.

Limited Lifetime Warranty

This product is warranted against defects in materials and workmanship, provided that:

1. The product was installed according to the product instructions.
2. Pro Design LLC recommendations were followed regarding limitations and specifications of the product.

Pro Design LLC reserves the right to determine if your shade warrants a repair or partial replacement of any parts. If necessary, Pro Design LLC will replace your shade with a new shade of equal or superior value. This shall be your sole remedy under this warranty.

This Limited Lifetime Warranty excludes all motors, controls and accessories, which are warranted for only a period of five years from the date of purchase. Failure to follow the proper installation, charging and use instructions will invalidate the warranty for motors, remotes, wands and hubs.

This Limited Lifetime Warranty applies only to the original retail purchaser with proof of purchase.

This Limited Lifetime Warranty does not cover the removal or installation of original or replacement shades. This Limited Lifetime Warranty does not cover damage or defects caused by, or resulting from improper maintenance, neglect or improper use, wear and tear, abuse, neglect, accidents, alteration, commercial use, installation, removal or reinstallation or exposure to excessive moisture.

Your Rights Under State Law

These warranties give you specific legal rights. You may also have other rights which may vary from State to State. In no event shall Pro Design LLC be liable for incidental or consequential damages or for any other direct or indirect damage, loss, cost, expense or fee. Some states do not allow the exclusion or limitation of incidental or consequential damages, so the above limitation or exclusion may not apply to you. These warranties are exclusive and in lieu of all other obligations, liabilities, disclaimers or warranties.

Please contact Customer Service with any question or concern:



inspired@prodesignllc.net



330-562-0023



330-294-9878